



# FICHE D'HOMOLOGATION / HOMOLOGATION FORM



COMMISSION  
INTERNATIONALE  
DE KARTING - FIA

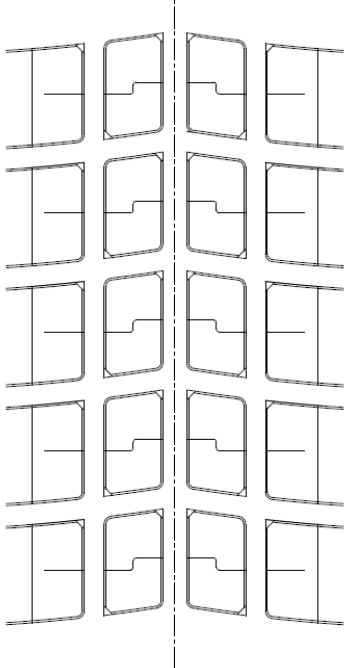

## PNEUMATIQUE / TYRE 5" WET MINI

Constructeur / Manufacturer	VEGA S.r.l.
Marque / Make	<b>VEGA</b>
Modèle / Model	<b>WM1 CIK MINI 10X4.00-5</b>
Catégorie / Category	Group 3
Durée de l'homologation / Validity of the Homologation	3 ans / 3 years
Nombre de pages / Number of pages	4
La présente Fiche d'Homologation reproduit descriptions, illustrations et dimensions du pneumatique au moment de l'homologation CIK-FIA et du test d'homologation.	<i>This Homologation Form reproduces descriptions, illustrations and dimensions of the tyre at the moment of the CIK-FIA homologation and of the homologation test.</i>
	
Photo du pneu monté sur la jante / Photo of the tyre fitted to the rim	Dessin de la bande de roulement / Tread design drawing
Signature et tampon de l'ASN / Signature and stamp of the ASN	Signature et tampon de la CIK-FIA / Signature and stamp of the CIK-FIA
	

Descriptions Techniques	Descriptions Techniques
Sous une température de 23°C +/-2°C, avec une humidité de 50% +/-5%	At a temperature of 23°C +/-2°C and with a humidity of 50% +/-5%

Pt	Descriptions / Descriptions	Valeurs / Value		Tolérances / Tolerances	
1	Dimensions / Dimensions	10x4.00-5		--	
2	Désignation du mélange / Tread compound designation	WM1		--	
3	Pression de service / Service pressure	1 bar		+/- 0.3 bar	
4	Pression de gonflage / Inflation pressure	4 bar		max	
5	Capacité de charge / Load capacity	80 kg		max	
6	Vitesse maximale / Maximum speed	140 km/h			
7	Rigidité latérale et verticale (sous charge de 40 kg) / Lateral and vertical stiffness (under 40 kg load)	L = 2 , V = 20mm		L: +/-1 V: +/-2	
8					
9	Profondeur du profil / Depth of tread	4.7 mm		+/- 0.5 mm	
10	Poids en grammes / Weight in grams	835		+/- 10%	
11	Nombre de plis / Numbers of plies	2		--	
12	Épaisseur de la bande de roulement / Tread thickness	5 mm		+/- 1.0 mm	
13	Nombre d'indicateurs d'usure du pneu / Number of tread wear indicators	--		--	
14	Matériau de la carcasse / Carcass material	NYLON		--	
15	Angle de tissage de la toile du pneu / Angle of tyre canvas	31°		+/- 3°	
16	Type de fil de tissage (selon ISO) / Canvas thread type (according to ISO)	940		--	
17	Pneu tubeless / Tubeless tyre	Yes		--	
18	Dureté superficielle de la bande de roulement (ISO 48: 2018 – 2 échantillons de 2 mm d'épaisseur) / Superficial tread hardness (ISO 48: 2018 – 2 samples of 2 mm thickness)	38.6		+/- 5 DIDC - IRHD	
19	Contrainte-déformation en traction (ISO 37:2017 – éprouvette type 3) / Tensile stress-strain (ISO 37:2017 – type 3 sample)	à / at 100%	à / at 300%	à / at 100%	à / at 300%
				+/- 0.5 MPa	+/- 0.8 MPa
20	Largeur de la bande / Tread width	65 mm		Avant/Front : max. 80 mm	

Dessin	Drawing
--------	---------

Dessin du pneu en section transversale et dimensions du pneu monté sur une jante / Drawing of tyre cross section and dimensions of the tyre fitted to a rim	Dimensions / Dimensions	Tolérances / Tolerances
	Ø 255 mm	+/- 5 mm
	Ø 126.2 * mm	+0/-1.0 mm
	155 mm	+/-5 mm
	75 mm	+/-5 mm
	105 mm	+/- 5 mm
<p>*Dimension selon Dessin Technique N° 4 jante 5" standardisée / Dimension according to Technical Drawing N° 4 standardised 5" rim</p>		

DESSIN TECHNIQUE N°4

Jante 5"

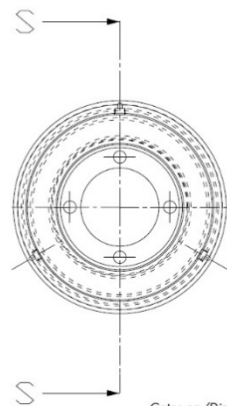

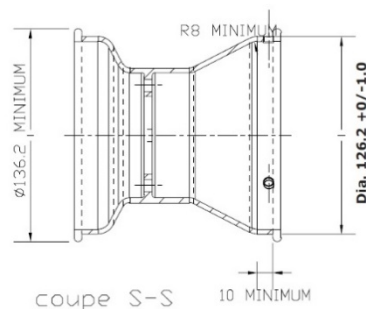

TECHNICAL DRAWING No. 4

5" Rim



coupe S-S 10 MINIMUM

Photos et Inscriptions	<i>Photos and Inscriptions</i>		
Seules les inscriptions qui ne changeront pas tout au long de la fabrication sont reportées ci-dessous.	<i>Only inscriptions which will not change during production are mentioned below.</i>		
Photo du flanc extérieur du pneu / <i>Photo of tyre external sidewall</i>	Inscription sur le flanc extérieur du pneu / <i>Inscriptions on tyre external sidewall</i>		
	<b>Texte / Text</b>	<b>Hauteur / Height</b>	<b>Trait / Stroke</b>
	VEGA (printed)		
	KART >>	9.5 mm	2.8/4 mm
	10 x 4.00 – 5	6.5 mm	3 mm
	Max inflation pressure 4 bar	3.8 mm	1 mm
	Barcode		
Photo du flanc intérieur du pneu / <i>Photo of tyre internal sidewall</i>	Inscription sur le flanc intérieur du pneu / <i>Inscriptions on tyre internal sidewall</i>		
	<b>Texte / Text</b>	<b>Hauteur / Height</b>	<b>Trait / Stroke</b>
	VEGA	13 mm	3/8 mm
	10 x 4.00 – 5	6.5 mm	3 mm
	Made in Italy	3.8 mm	1 mm
	Tubeless	3.8 mm	1 mm
	For racing purpose only	3.8 mm	1 mm
	WM1	8.5 mm	3.5 mm
	CIK Mini	5 mm	2 mm
	Barcode		